

MASY

KINGDOM OF BAHRAIN

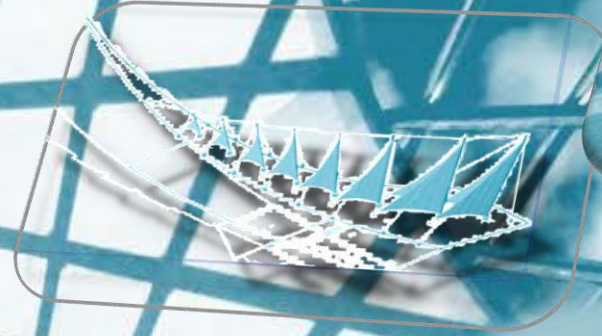

GROUP

MASY

Middle East

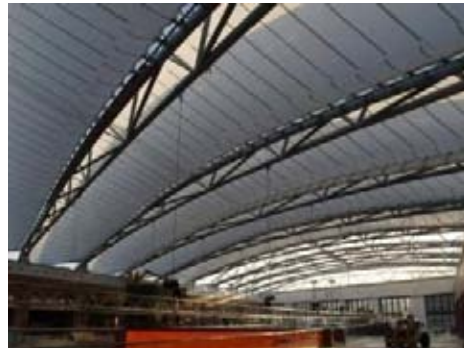

Germany



texshade

A Joint Venture with Textil Bau GmbH-Germany.

India



Germany



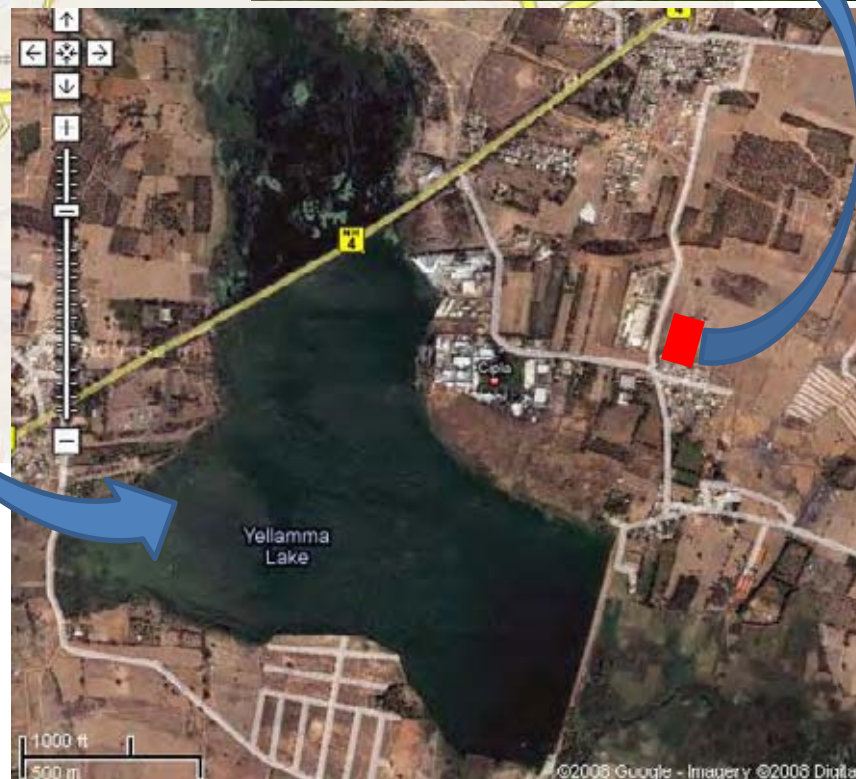
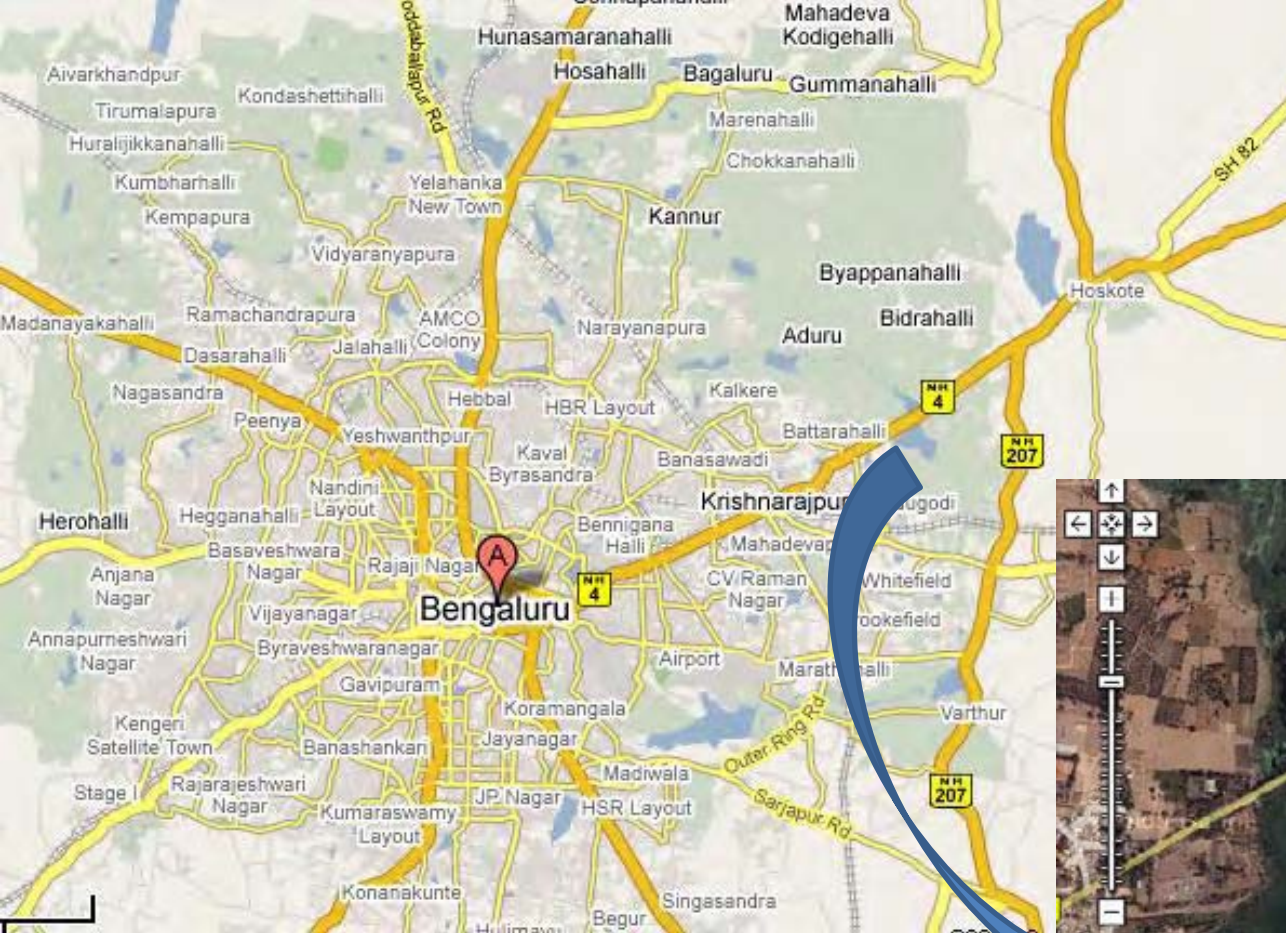

LOCATION

Texshade prefabs Pvt.Ltd.

**No.1, Survey no 51/1, Opp.NSP Electronics,
Avalahalli, Virgo agar post,
Bengalure – 560049, Karnataka, INDIA.**





DESIGN
STUDIO



MASY

texshade
A Joint Venture with Troff Bau GmbH Germany



MEMBRANE PRODUCTION FACILITY
AREA = 1500 m²



TECHNOLOGY

HF – High frequency PVC fabric welding machine



HB – Heat Bar PFE & Glass silicon fabric welding machine

S.S Cable Swaging machine

TECHNOLOGY



High quality welding with varying widths



HF – High frequency traveling welding machine for long span welding

MASY

A Joint Venture with Treff Bau GmbH Germany

Tensile Structure design, analysis and manufacturing system by Advanced

ForTen 3000 Software

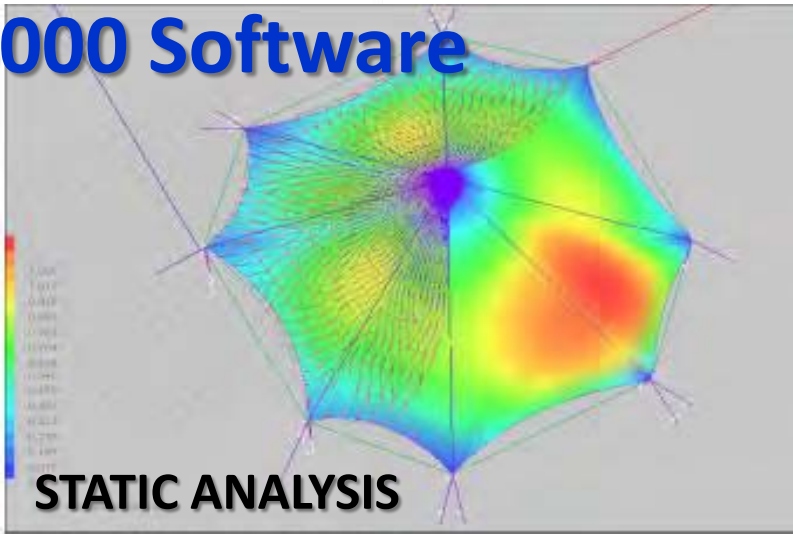

STATIC ANALYSIS

LOAD CASE LCD4 : MEMBRANE DEFLECTIONS

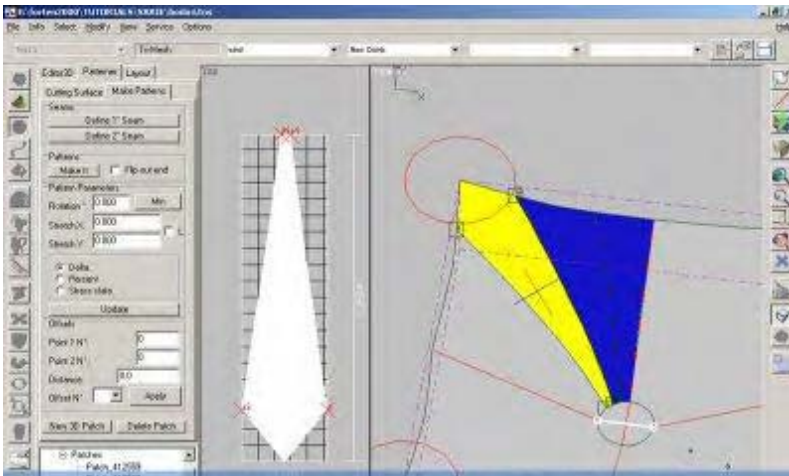

PANNING

cut shapes with circle and cross section
by using end point and intersection features

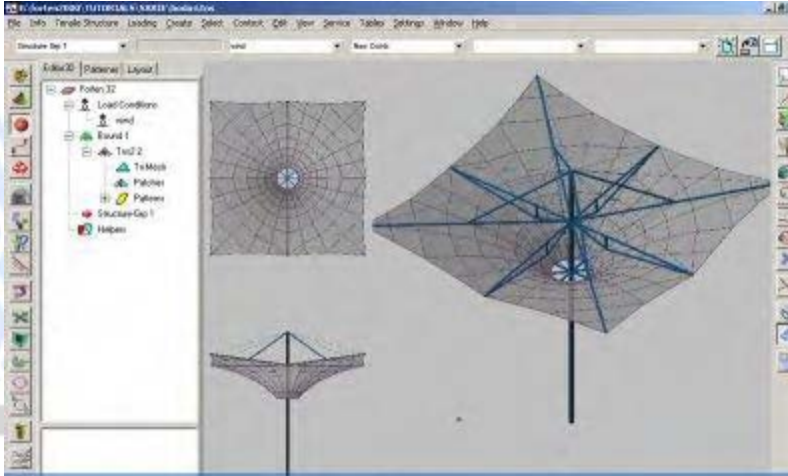

STEEL ANALYSIS meter umbrella

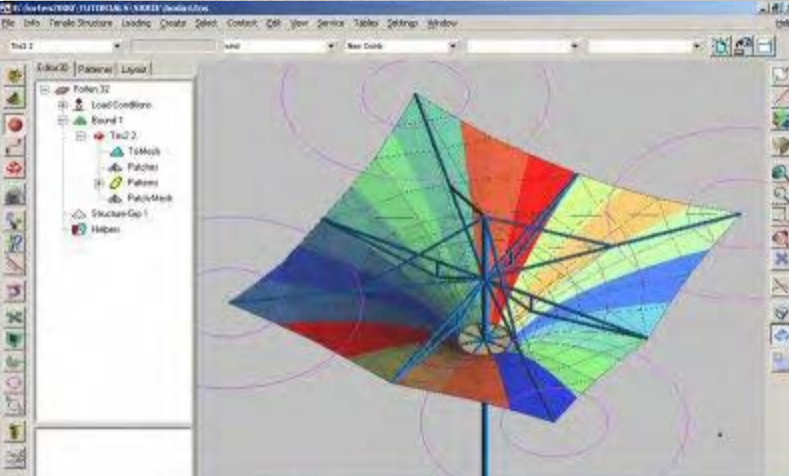

DESIGN ANALYSIS in 3d



Engineering and Workshop drawings

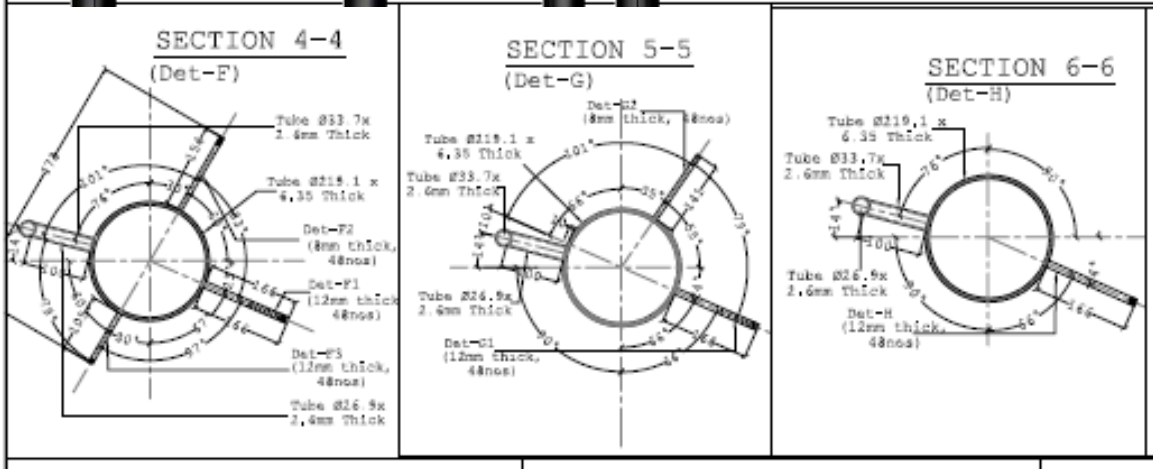
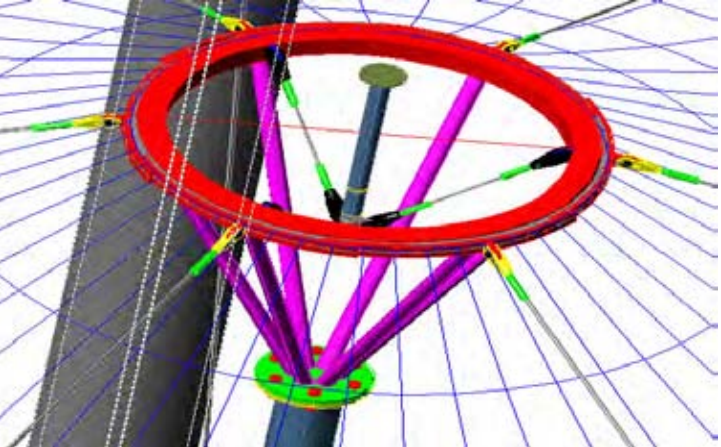
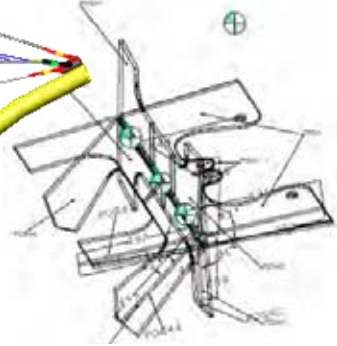
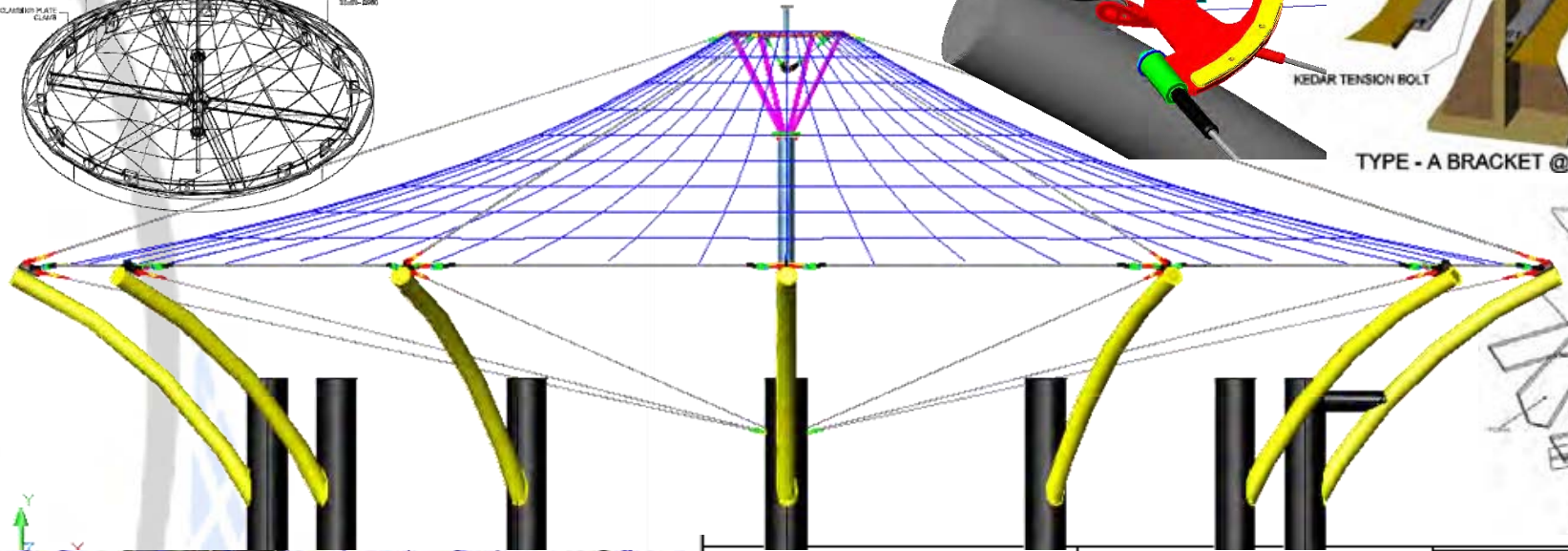
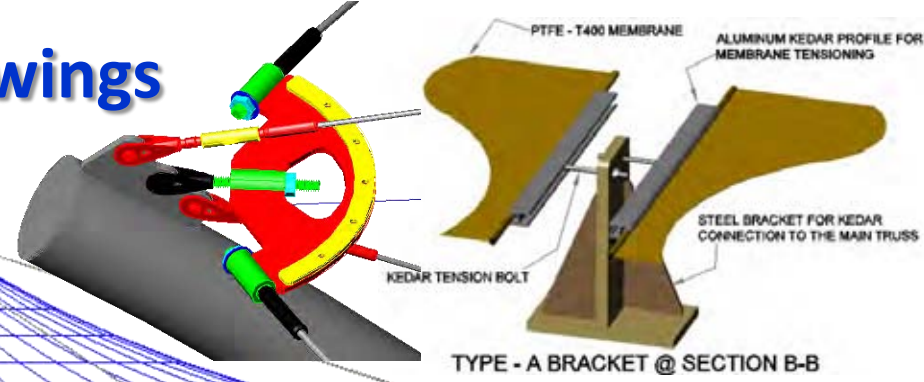
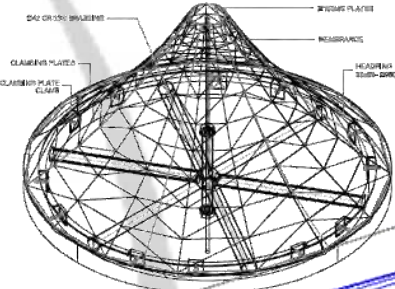

SKILLED WORKFORCE



CLIMBING SEMINAR FOR TEXSHADE FACTORY TEAM - AT CAPE CLEAN

Date: 24th June '08





HI-TECH STEEL DETAILING



MASY

texshade
A Joint Venture with Trefft Bau GmbH Germany



HI-PERFORMANCE STRUCTURES FOR SHIPS

MASY/TEXSHADE RECENTLY COMPLETED PROJECT



MANAMA SOUQ DEVELOPMENT SHOPPING MALL - 2009

CLIENT: MoMAA
ARCHITECT: GULF HOUSE ENGINEERING
CONTRACTOR: BOKHOWA GROUP
AREA: 1000 m²
FABRIC: PTFE FIBERTOP T-400

MASY

texshade
A Joint Venture with Treff Bau GmbH Germany

MASY/TEXSHADE RECENTLY COMPLETED PROJECT

THE DRAGON - BAHRAIN – 2009

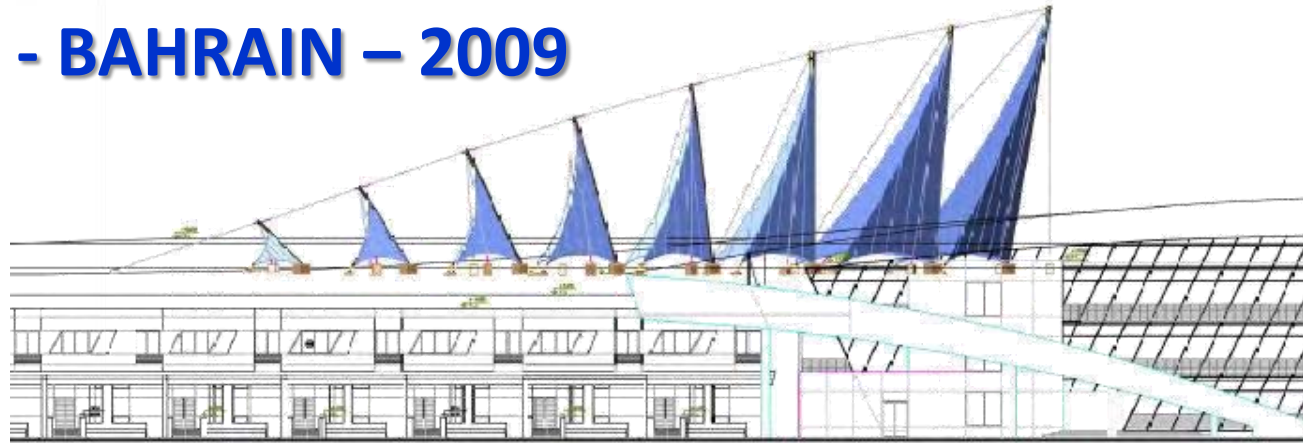

THE DRAGON HOTEL

CLIENT: AMWAJ ISLANDS
CONTRACTOR: SKYLINE CONTRACTING
AREA: 600 m²
FABRIC: FERRARI PVC 1202 T2

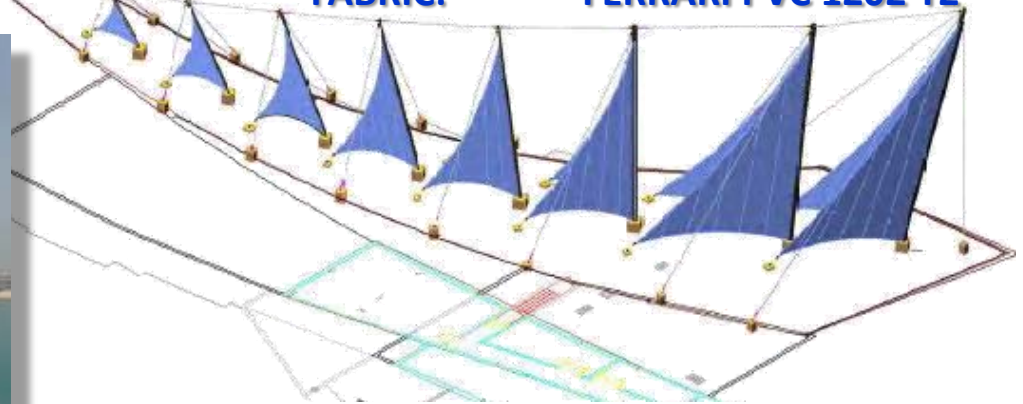

MASY/TEXSHADE RECENTLY COMPLETED PROJECT

THE DRAGON - BAHRAIN – 600 m²

FABRIC TYPE - PVC

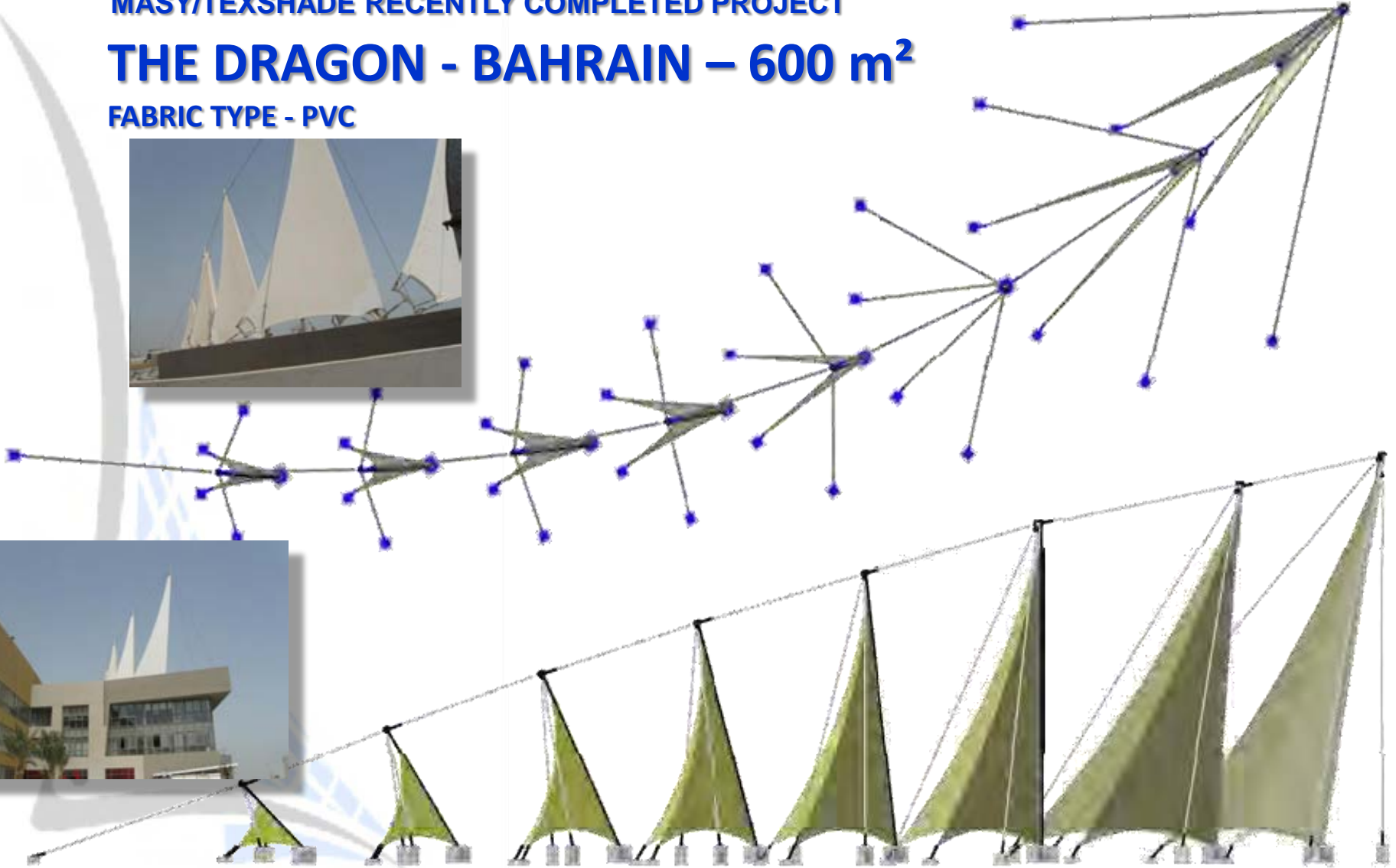

MASY/TEXSHADE RECENTLY COMPLETED PROJECT

ADHARI PARK-BAHRAIN – 2007



ADHARI PARK PAVILLION TENT

CLIENT: ADHARI PARK COMPANY

ARCHITECT: GULF HOUSE ENGINEERING

CONTRACTOR: Tabet Enterprises

AREA: 1500 m²

FABRIC: PTFE C1008



MASY

texshade
A Joint Venture with Trellis Bau GmbH Germany

MASY/TEXSHADE RECENTLY COMPLETED PROJECT

ADHARI PARK-BAHRAIN - 2007

MISCELLANEOUS SHADING

CLIENT:

ADHARI PARK COMPANY

ARCHITECT:

GULF HOUSE ENGINEERING

CONTRACTOR:

TABET ENTERPRISES

FABRIC:

FERRARI PVC 702S



**WALKWAY
SHADE**



**CAR PARKING
SHADE**



WINDOW SHADE

MASY

texshade
A Joint Venture with Trellis Bau GmbH Germany

MASY/TEXSHADE RECENTLY COMPLETED PROJECT

BAHRAIN UNIVERSITY – *Sakhir Camp* - 2008



COLLEGE OF IT WALKWAY

CLIENT:
MINISTRY OF WORKS
ARCHITECT:
ARIF SADEQ CONSULTANTS
CONTRACTOR:
TECHNICAL CONSTRUCTION
AREA: 5500 m²
FABRIC: FERRARI PVC 1302S



MASY

texshade
A Joint Venture with Trellis Bau GmbH Germany

MASY/TEXSHADE RECENTLY COMPLETED PROJECT

ROYAL PAVILLION – BAHRAIN *Amwaj Islands - 2006*



ROOFING SHADE FOR ROYAL PAVILLION

CLIENT: AMWAJ ISLANDS
ARCHITECT: PLANNING & DESIGN
CONTRACTOR: SKYLINE TRADING
AREA: 820 m²
FABRIC: FERRARI PVC 1202 T2



MASY

texshade
A Joint Venture with Trellis Bau GmbH Germany

MASY/TEXSHADE RECENTLY COMPLETED PROJECT



AL WADI MALL ATRIUM SHADE

**ARCHITECT:
BAHRAIN ENGINEERING BUREAU
CONTRACTOR:
AL NAMAL CONSTRUCTION
AREA: 300 m²
FABRIC: FERRARI PVC 1002 T2**



**G.O.Y.S
ENTRANCE CANOPY**

**CLIENT: G.O.Y.S.
FABRIC:
FERRARI PVC 702S**



**LIMASOOL COURT
GARDEN CANOPY**

**CONTRACTOR:
ZIMCO CONSTRUCTION
AREA: 200 m²
FABRIC: FERRARI PVC 1002 T2**

MASY/TEXSHADE RECENTLY COMPLETED PROJECT

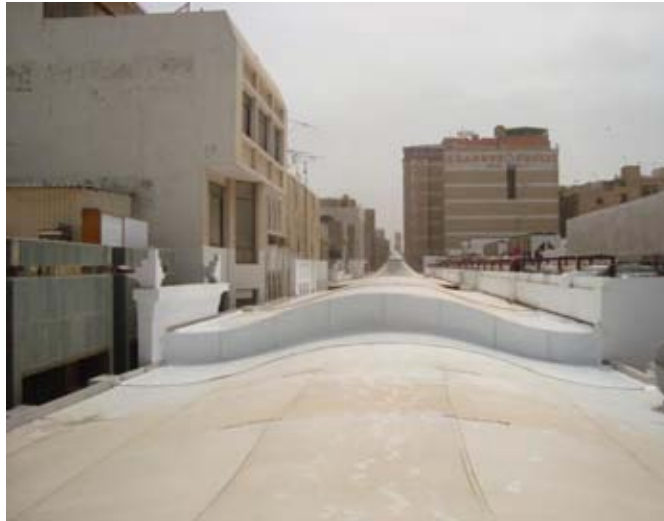

BAB AL BAHRAIN ROAD WALKWAY SHADES- 2010

CLIENT: MoMAA
ARCHITECT: GULF HOUSE ENGINEERING
CONTRACTOR: BOKHOWA GROUP
AREA: 950 m²
FABRIC: PVC Ferrari – 1002T2

MASY

texshade
A Joint Venture with Trellis Bau GmbH Germany

MASY/TEXSHADE RECENTLY COMPLETED PROJECT

Private Villa Swimming Pool – 2009



Private Villa Swimming Pool Shade

CLIENT: Private

ARCHITECT: Direct Client

CONTRACTOR: Direct Client

AREA: 400 m²

FABRIC: 1002S

MASY

texshade
A Joint Venture with Trellis Bau GmbH Germany

MASY/TEXSHADE RECENTLY COMPLETED PROJECT

BAPCO Awali Park – 2010



BAPCO AWALI Main Pavilion

CLIENT: BAPCO

ARCHITECT: Landscape Consultants

CONTRACTOR: Direct Client

AREA: 400 m²

FABRIC: 1002 T2

MASY

texshade
A Joint Venture with Trefil Bau GmbH Germany

MASY/TEXSHADE RECENTLY COMPLETED PROJECT

Police Fort Grand Stand – 2011



Police Fort Grand Stand

CLIENT: Ministry of Interior

ARCHITECT: Client

CONTRACTOR: Hasan Mansouri W.L.L.

AREA: 260m²

FABRIC: Ferrari PVC-902S



MASY/TEXSHADE RECENTLY COMPLETED PROJECT

MTQ Oilfield Car Park – 2011



MTQ Oilfield Car Park Shade Structures

CLIENT: MTQ Oilfield Services W.L.L.

ARCHITECT: Tebodin Middle East W.L.L.

CONTRACTOR: Poullaides Construction Co.

AREA: 800 m²

FABRIC: Ferrari PVC-832



MASY/TEXSHADE RECENTLY COMPLETED PROJECT

Isa Sports City, Phase 1 – 2011



Isa Sports City, Phase 1

CLIENT: Ministry of Works & Housing

ARCHITECT: Ismail Khonji Associates

CONTRACTOR: Bokhowa Group

AREA: 350 m²

FABRIC: PVC – Ferrari 1002T2



MASY/TEXSHADE RECENTLY COMPLETED PROJECT

Enma'a Mall at East Riffa – 2011

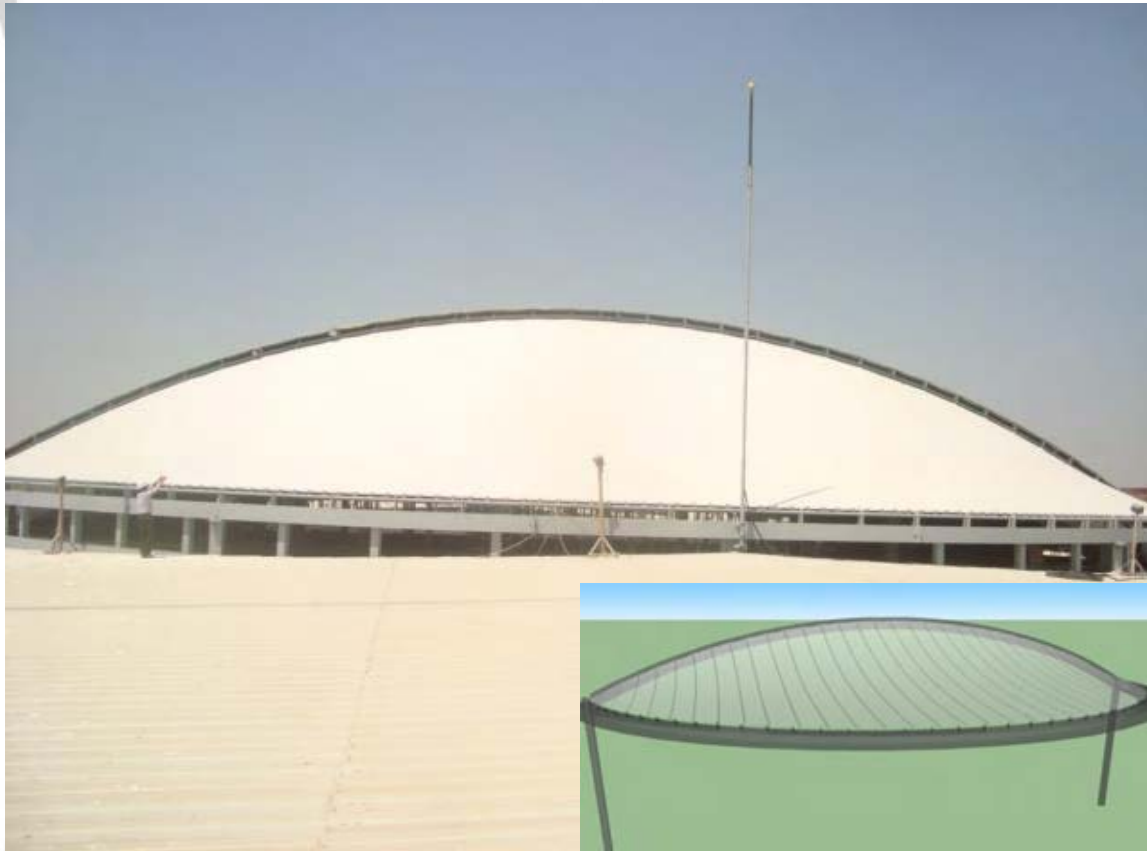

Enma'a Mall at East Riffa

CLIENT: Enma'a House

ARCHITECT: AREF SADEQ Consultants & Engineers AREA: 2,000 m²

CONTRACTOR: Al-Moayyed Constructions FABRIC: PVC – Ferrari 1002T2

MASY/TEXSHADE RECENTLY COMPLETED PROJECT

Spectators Gallery at Hidd – 2011

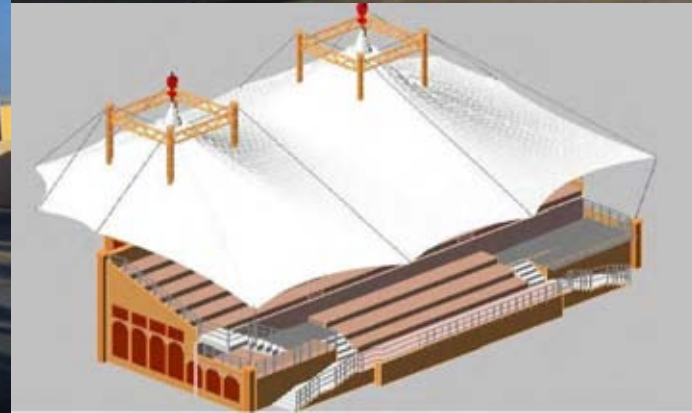

Spectators Gallery at Hidd

CLIENT: Ministry of Interiors

ARCHITECT: MOI

CONTRACTOR: M&I Constructions

AREA: 500 m²

FABRIC: PVC – Ferrari 1002T2

MASY

texshade
A Joint Venture with Trellis Bau GmbH Germany

MASY/TEXSHADE RECENTLY COMPLETED PROJECT

Iraq Embassy – 2012



Iraq Embassy

CLIENT: Private

ARCHITECT: Specialist Consultant

CONTRACTOR: Fakhrawi Constructions

AREA: 100 m²

FABRIC: PVC – Ferrari 502

MASY

texshade
A Joint Venture with Trellis Bau GmbH Germany

MASY/TEXSHADE RECENTLY COMPLETED PROJECT

LOT 10 Car Park at Reef – 2012



LOT 10 Car Park Shade Structures at Reef Island

CLIENT: Private

ARCHITECT: COWI

CONTRACTOR: Poullaides Constructions

AREA: 500 m²

FABRIC: PVC – Ferrari 502



MASY/TEXSHADE RECENTLY COMPLETED PROJECT

Manama Exhibition – 2012



Manama Exhibition at Bab Al-Bahrain, Manama

CLIENT: Ministry of Culture

ARCHITECT: PAD

CONTRACTOR:

AREA: 3,500 m²

FABRIC: HDPE

MASY

texshade
A Joint Venture with Trellis Bau GmbH Germany

MASY/TEXSHADE RECENTLY COMPLETED PROJECT

The Walk – 2012



The Walk at East Riffa

CLIENT: Private

ARCHITECT: Intec Bahrain

CONTRACTOR: G.P. Zachariades Overseas

AREA: 200 m²

FABRIC: PVC-Ferrari 902S

MASY

texshade
A Joint Venture with Tröfif Bau GmbH Germany

MASY/TEXSHADE RECENTLY COMPLETED PROJECT

Bahrain Training Institute – 2012



Bahrain Training Institute at Isa Town

CLIENT: BTI

ARCHITECT: MOW - CPD

CONTRACTOR: Mohammed Jalal Contracting

AREA: 1500 m²

FABRIC: PVC-Ferrari 1002S



WORKMANSHIP



QUALITY



STRENGTH & DURABILITY



SERVICE



MASY Shade

